

Hep₂O

Push-fit Plumbing Installer guide



Contents

Hep₂O Push-fit Plumbing

Introduction 5-9

Unique benefits	6
Market-leading 50 year guarantee	7
Easier installation and proven performance	7-8
Approvals	9

Basics 10-23

Hep ₂ O Polybutylene pipe	10
Straight	10
Coil	10
Standard pipe	11
Barrier pipe	11
Cutting Hep ₂ O pipe	12-13
Hep ₂ O fittings	14
Jointing with Hep ₂ O pipe and fittings	15
Jointing procedure	16
Jointing copper pipe to Hep ₂ O fittings	17
Checking the joint using In4Sure™ joint recognition technology	18
Demounting joints using the Hep ₂ O	19-20
Hints and tips for trouble-free Hep ₂ O installation	21
Hep ₂ O pipe	21
Handling and storage	22
Hep ₂ O fittings	22
Colour-coded packaging	23

Other Jointing Applications 24-29

Connecting Hep ₂ O pipe to compression fittings	24
Hep ₂ O connections adjacent to capillary joints	25
Connection to chrome plated or stainless steel pipe	25
Connection to brass spigots	25
Connection to earlier Hep ₂ O systems	25
Connecting Hep ₂ O fittings to other brands of pipe	26
Connecting Hep ₂ O to steel pipes and threaded bosses	26
Connections to appliances using Hep ₂ O	27
System alterations	27
Using a Blanking peg to seal off a fitting	27

Contents

Hep₂O Push-fit Plumbing

Where it's OK to use Hep ₂ O	28
Using a stop end to seal off a pipe	28
Where it's not OK to use Hep ₂ O	29

Sitework **30-48**

Cabling through joists	30
Less risk to health and greater site safety	31
Hep ₂ O push-fit jointing also has the following advantages:	31
Other system benefits include:	31
Drilling the floor joists	32
Engineered joists	33
Spigot tees and manifolds	33
Connecting pumps, valves etc.	34
Pipe support	34-35
Cable ties	36
Pipe support distances	36
Pipework installation	37
Concealed locations	37
Use of metal tape to aid 'electronic' pipe detection	38
Pipes through walls and floors	39
Laying pipe in floor screeds	39
Pipes adjacent to metalwork	39
Hep ₂ O pipe means quieter operation because there's less noise...	40
...from friction	40
...from knocking	40
...and from 'water hammer'	40
Installing pipes in concrete floors or walls	40
Hep ₂ O Conduit system	40
Installation	41-43
Fitting a junction box	44
Fitting pipe into conduit	45
Terminating the conduit	46
Terminating the conduit continued	47
Hep ₂ O Pipe-in-Pipe system	48

Heating Systems **49-58**

Dry lined wall feeds for radiators	49
------------------------------------	----

Radiator outlet cover plate	49
First-fix radiator feeds	50
Connecting Hep ₂ O pipe to storage vessels and radiators	51
Connecting Hep ₂ O to ancillaries (pumps, valves, etc.)	52
Connecting boilers and heaters	52-53
Manifolds	53
Cutting a manifold spigot end	54
Installation and performance benefits	55
Hep ₂ O within internal drywall systems	55-56
Hep ₂ O within timber framed and steel framed buildings	57
General advice	58

Important Information 59-61

Continuously operated re-circulating systems (Secondary Hot Water Circulation / Ring main installations)	59
Freezing for maintenance/system modification	59
Painting Hep ₂ O	59
Use of corrosion inhibitors	60
Antifreeze	60
Electrical safety	60
Equipotential bonding	61
Woodworm / timber treatment	61

Precautions 62

External installations	62
Vermin	62
Chlorine	62

Testing 63-64

Pressure testing	63
Test procedure	64
Low Pressure Leakage Test	64
High Pressure Hydraulic Test	64
Test Procedure	64

Contents

Hep₂O Push-fit Plumbing

Special Applications **65-66**

Boats	65
Caravans	65
Exhibitions	65
Portable buildings, site cabins, toilets etc.	65
Agriculture and horticulture	66

Fault Finding **67-68**

In the unlikely event of a problem occurring, the following notes will help to identify the cause: **67**

Typical Problems	67
1. Joint weeps	67
2. Split fittings	67
3. Pipe or fitting melting	68

General Information **69**

Advisory service	69
Other sources of information	69

Product Selector **70-80**

Polybutylene Pipe **70**

Demountable Fittings **71-73**

Flexible Tap Connectors **74-75**

Auxiliary Fittings **76-78**

Tools, Fixings and Accessories **79-80**

Conduit System **80**

Introduction

Hep₂O Push-fit Plumbing

This Installer guide is designed to help professional plumbers obtain the best results when using Hep₂O plastic push-fit fittings and pipe. It provides guidance on good plumbing practice and comprehensive advice to enable users to get the best possible performance from the Hep₂O system.

Hep₂O is a fully tried and tested system and has been the first choice of professional plumbers in the UK for over 30 years. With many unique and patented features, Hep₂O is the most technologically advanced fitting on the market..

Hep₂O is available in 10, 15, 22, and 28mm and our packaging in colour coded to make identification easy in branch:

- 10mm: green
- 15mm: blue
- 22mm: purple
- 28mm: orange

Figure 1: Hep₂O push fit system



Introduction

Hep₂O Push-fit Plumbing

Unique Next Generation benefits

We've listened to our customers, all professional plumbers and heating engineers, and we've responded to their wish list with some unique features that are not available with any other comparable push-fit system:

Figure 2: Cross section of Hep₂O fitting

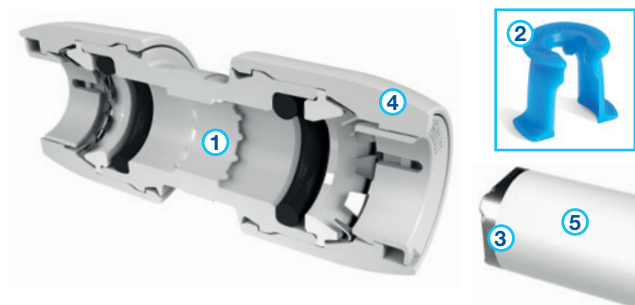

1. In4Sure™ joint recognition tells you when the pipe's inserted

Just insert the pipe into the fitting then rotate it. If it's fully inserted you'll feel a 'rumbling' sensation, caused by the profiled end of the pipe support sleeve making contact with the castellated seat inside the fitting.

2. HepKey™ demounting system

The HepKey™ makes demounting quick, easy and tamper-proof, so joints only come apart when you want them to.

3. SmartSleeve™ for reduced force joint assembly

As well as forming part of the new In4Sure™ technology, the design of the new SmartSleeve™ pipe support sleeve also reduces the force required to push the pipe into the fitting.

4. White fittings with sleek look

The white colour combined with a slimmer, more streamlined and altogether more stylish design, means Hep₂O fittings are now much more acceptable for 'on view' applications.

5. Flexible pipe

Our polybutelene pipe is highly flexible and can be easily cabled, but also has straight coil technology so when uncoiled the pipe remains straight.

Market-leading 50 year guarantee

Due to a rigorous quality control and testing programme, all Next Generation Hep₂O pipe and fittings are guaranteed for 50 years against defects in materials and manufacturing.

The only stipulation is that good professional installation practice is followed, as outlined in this guide. Notably, this includes working within the peak life cycle operating temperatures and pressures detailed in Table No.1 - see page 9.

Easier installation and proven performance

Hep₂O has evolved over 30 years and is now recognised as the professional's system of choice. With significant performance benefits, easier and quicker installations without any compromise on quality or joint integrity. Pipe flexibility and joint security remain the key benefits of Hep₂O.

- ⦿ Flexible pipe means it can more easily be 'cabled' around obstructions
- ⦿ 'Cabling' the pipe means fewer joints are required
- ⦿ Fewer joints reduce installation time and system costs
- ⦿ Push-fit also means no naked flames with reduced inherent risks

There are also significant long-term performance benefits over traditional rigid metal systems.

- ⦿ Plastic pipe means no scale build-up
- ⦿ No corrosion and reduced risk of burst pipes
- ⦿ Quieter in service, cooler to the touch and less heat loss

Introduction

Hep₂O Push-fit Plumbing

Figure 3: Hep₂O offers significant benefits over traditional systems



Easy demounting with **HepKey™**



Easy cabling. Fewer joints



High resistance to impact



Measure and cut in-situ

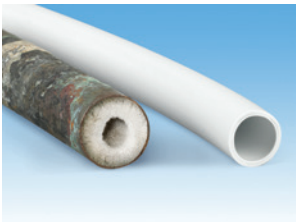

No scale build-up

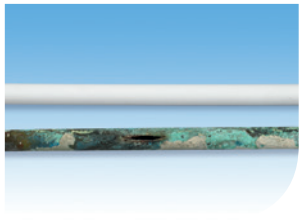

No bursts. Corrosion free

Approvals

Hep₂O carries a British Standard Kitemark against BS7291 parts 1 & 2 Class S. Standard pipe and fittings also carry a British Standard Kitemark against BS EN ISO 15876. Barrier pipe and fittings also carry a British Standard Kitemark against BS EN ISO 21003.

All products are manufactured under the scope of a Quality Management System that is third party accredited to BS EN ISO 9001:2008.



BS 7291



1312005

Hep₂O is listed in the Water Fittings and Materials Directory – listing number 0812080.

Hep₂O is suitable for use in domestic water distribution and central heating systems including pressurised systems and combination boilers in accordance with Table No. 1. It may also be used in buildings other than dwellings providing the service conditions are not exceeded.

Hep₂O pipe is offered in two types, Standard and Barrier (see pages 11-12). Both are accepted by British Gas / Scottish Gas Central Heating Care Contracts

Table 1: Peak life cycle operating temperatures/pressures

	20°C	30°C	40°C	50°C	60°C	70°C	80°C	95°C	114°C*
Safe pressures:									
Bar	12	11.5	11	10.5	9	8	7	6	3
psi	174	167	160	152	131	116	102	87	43.5
Head of water (m)	120	115	110	105	90	80	70	60	30

*Short Malfunction at 114°C

Basics Hep₂O Push-fit Plumbing

Hep₂O Polybutylene pipe

Available in straight lengths or coils in Standard or Barrier.

Straight

Straight lengths of Hep₂O Standard and Barrier pipe are supplied in 3m lengths in 15mm, 22mm and 28mm diameters. Straight pipe is just as flexible as coiled pipe and is primarily intended for exposed pipework where neatness is vital, or where only a short length of pipe is required.

Coil

A unique characteristic of Hep₂O pipe coil is its remarkable ability to remain straight once uncoiled, unlike some other plastic materials which act like a spring. This makes handling so awkward that two men may well be required to carry out a relatively simple job.

Hep₂O pipe is much easier to handle and much easier to cable because of its inherent tendency to stay where it's put.

Figure 4: Hep₂O pipe (left) comes off the coil straight



Coiled Hep₂O pipe is supplied in 25m to 100m coils, in 10mm, 15mm, 22mm and 28mm diameters, in a SmartPack™ dispenser.

- ⦿ Choice of Standard or Barrier pipe
- ⦿ Uncoiled pipe retains its flexibility
- ⦿ For installations into screed use the Hep₂O 'Pipe-in-Pipe' system. This incorporates Hep₂O Barrier pipe in a pre-sheathed conduit

Standard pipe

- ⦿ Suitable for domestic hot/cold water and heating applications
- ⦿ When used for heating, a suitable inhibitor such as Sentinel or Fernox MB1 should be used

Barrier pipe

- ⦿ Designed for central heating systems
- ⦿ Incorporates an oxygen barrier to inhibit oxygen permeation
- ⦿ Use of inhibitors are recommended as corrosion can occur in all types of system regardless of pipe material
- ⦿ May also be used for domestic hot and cold water services

Note: Hep₂O pipe is NOT suitable for conveying gas, oil or underground supplies.

Figure 5: Hep₂O offers a range of pipe options



- ⦿ Cut length:
Standard and Barrier straight cut lengths



- ⦿ Standard coiled pipe:
Straight coiled lengths in SmartPack™ dispenser

Basics

Hep₂O Push-fit Plumbing



- Barrier coiled pipe:
Straight coiled lengths in SmartPack™ dispenser



- Pipe-in-Pipe system:
Hep₂O Barrier pipe in blue or red conduit

Cutting Hep₂O pipe

Recommended cutters (HD74, HD75, HD77 or HD78), as shown in the current Hep₂O Trade Price List should be used to cut Hep₂O pipe. Place the pipe in the jaws of the cutter and apply pressure, then rotate the pipe and maintain the pressure until it is severed (see Fig. 6).

Before making a joint, check that the pipe end is clean, cut square and free from burrs and surface damage.

Figure 6: Always use recommended cutters to cut Hep₂O pipe

Do use recommended cutters to cut the pipe.

Do test the pipe is fully inserted into the fitting when making a joint using our In4Sure™ technology. Calculate the correct pipe length, cut the pipe at one of the cutting marks ‘^’ printed onto the pipe (see Fig. 8). The distance between the ‘^’ marks is the insertion depth into the fitting and this should be allowed for.



Figure 7: Don't use a hacksaw to cut Hep₂O pipe

Don't use a hacksaw to cut Hep₂O pipe.

Don't use damaged pipe.

Ensure pipe ends are free from burrs and surface damage. If not, re-cut the pipe.

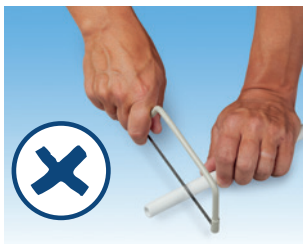
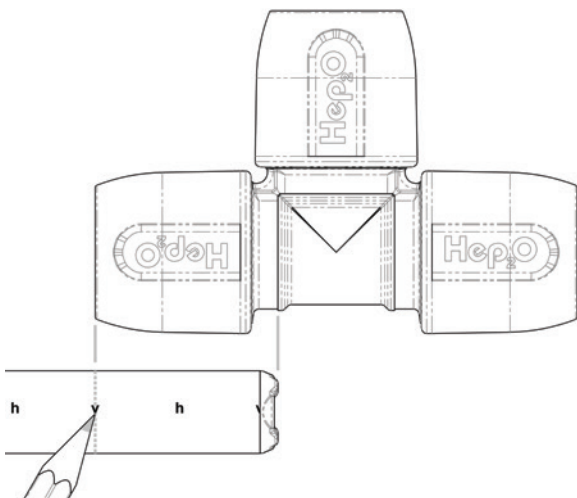

Table 2: Correct insertion depths for Hep₂O fittings

Pipe size (mm)	Nominal insertion depth including sleeve (mm)
10	28
15	32
22	33
28	36

Note: SmartSleeve™ support sleeve is an integral part of the system and should **NEVER** be omitted when using Hep₂O pipe.

Figure 8: Hep₂O 15mm assembly with pipe markings



Basics

Hep₂O Push-fit Plumbing

Hep₂O fittings

Hep₂O fittings are only available in white. They are offered in colour-coded packs (see 'Packaging', page 23) in a range of sizes 10, 15, 22 and 28mm and in a comprehensive range of types to answer all domestic hot/cold water and heating applications.

All O-ring seals contained in Hep₂O fittings have been pre-lubricated during factory assembly and during normal installation additional lubrication should not be required.

If the fitting has been used previously or if fittings have been un-bagged for several weeks, then the lubricant may have been removed or dried out and may require replacing. In these situations Hep₂O Jointing Lubricant Spray (code HX200) must be used to avoid contravention of Water By-laws and ensure compatibility with other system materials (see Figure 9).

Don't use other manufacturer's lubricant or any alternative.

Figure 9: Spraying used O-ring with silicone lubricant



Joining with Hep₂O pipe and fittings

SmartSleeve™ pipe support sleeve

Before making a joint using Hep₂O pipe, it is essential to insert a Hep₂O SmartSleeve™ pipe support sleeve into the cut pipe end (see Figure 10). The only exception is when connecting to the open spigot end of a Hep₂O fitting.

The **SmartSleeve™** has several purposes:

- ④ It ensures the pipe retains its circular cross-section
- ④ It eases insertion of the pipe into the fitting
- ④ The profiled end of the **SmartSleeve™** helps you to check the pipe is fully inserted. See **In4Sure™** joint recognition technology (see page 18)
- ④ It maintains the rigidity of the pipe within the fitting
- ④ It retains the circular cross-section of the pipe under extreme temperatures
- ④ Barbs on the **SmartSleeve™** lock it in the pipe, which helps ensure it is not left in the fitting when demounting

All **SmartSleeve™** pipe inserts are manufactured from 'food quality' 316 stainless steel and are impervious to contaminants. They are designed to be captive in the pipe but can be removed if required, using long nosed pliers. However, if damaged, the **SmartSleeve™** must not be re-used.

Figure 10: Inserting SmartSleeve™ into pipe

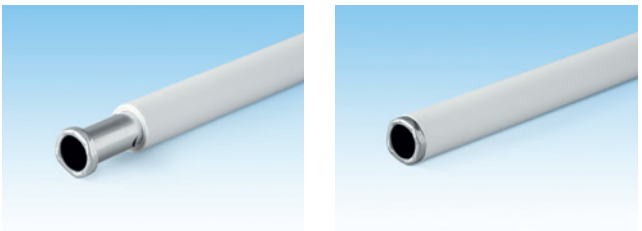

Basics Hep₂O Push-fit Plumbing

Joining procedure

Whichever type of Hep₂O fitting is used, the same joining procedure should be followed:

Figure 11: Hep₂O joining sequence



- ④ Cut the pipe squarely at one of the '∧' marks using recommended pipe cutters and ensure the pipe end is free from burrs (see page 12)



- ④ Insert a Hep₂O **SmartSleeve™** pipe support sleeve into the pipe end



- ④ Push the pipe firmly into the fitting, then use Hep₂O's unique **In4Sure™** joint recognition technology to 'feel' if the pipe is fully inserted (see page 18)



- ④ Tug back on the pipe to ensure the grab-ring engages correctly and prevents the pipe withdrawing

Joining copper pipe to Hep₂O fittings

Hep₂O fittings have been designed to form reliable joints with metric copper pipe which conforms to BS EN 1057 – R250.

1. Measure the pipe, allowing sufficient length for insertion into the fitting, and mark with a pencil (see Table No. 2).
2. Cut the copper pipe with a wheel cutter.
3. Carefully inspect the pipe ends for burrs or swarf.
4. Push the pipe firmly into the fitting.
5. Tug back on the pipe to ensure the grab-ring engages correctly and prevents the pipe withdrawing.

Figure 12: Hep₂O fittings are also compatible with copper pipe

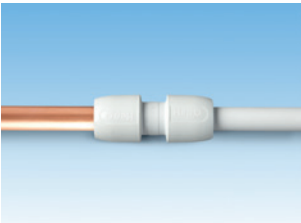
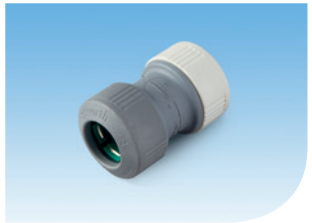

Figure 13: HD3A/22 3/4" Imperial/22mm adaptor



With a little extra care, it is also possible to connect 10mm BS EN 1057 - R220 copper pipe into Hep₂O fittings.

R220 pipe is particularly 'soft' and therefore susceptible to becoming misshaped or dented if it is not handled with care. Particular attention should be paid to the cut end, looking for any signs of damage. R220 copper pipe should be cut with a mini wheel cutter, and then a chamfer should be filed on the pipe and any copper filings rinsed away, and the pipe dried-off.

Hep₂O can also be connected to 3/4" Imperial copper pipe using a special O-ring straight adaptor (HD3A/22) which accepts 22mm copper pipe at one end and 3/4" Imperial copper pipe at the other.

Note: New pipe insert for copper providing joint recognition will be available soon.

Basics

Hep₂O Push-fit Plumbing

Checking the joint using In4Sure™ joint recognition technology

Follow normal procedure to establish the insertion depth of the pipe into the fitting as previously described (see page 16).

In4Sure™ joint recognition technology then provides a further check by allowing you to ‘feel’ if the pipe is fully inserted.

Figure 11: Cut-away showing **In4Sure™** joint recognition

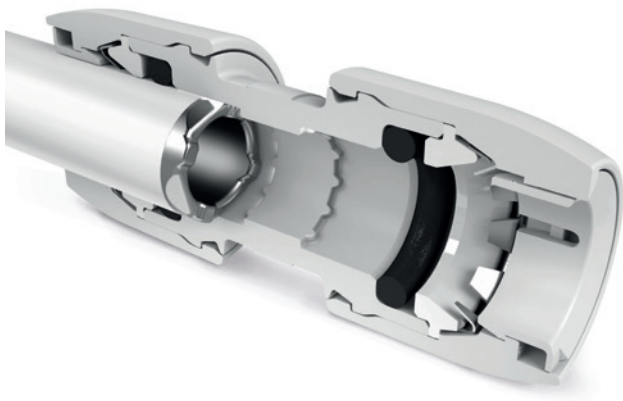

To use **In4Sure™** joint recognition technology:

1. Hold the centre (fixed) part of the fitting in one hand.
2. After inserting the appropriate pipe sleeve, push the pipe firmly into the fitting.
3. While still pushing, rotate the pipe using a screwing action. If the pipe is fully inserted you will feel a ‘rumbling’ sensation as the profiled end of the **SmartSleeve™** passes over the castellated seat inside the fitting.
4. Pull back to check the joint integrity.

This simple procedure is designed to give you the peace of mind that comes from knowing that the joint is good. You can also make a visual check by checking the next ‘^’ mark is level with the end of the fitting.

Demounting joints using the Hep₂O

Three types of demounting tool are available:

- ① **HepKey Plus™** simply clips onto the fitting and holds the grab-ring in its release position
- ① The **HepKey™** is small enough to be kept in your pocket
- ① **HepTool™** is a specialist metal demounting tool which can help in restricted spaces, for example where a fitting is hard up against a wall or another fitting

Figure 15: **HepKey Plus™**



Figure 16: **HepKey™**



HepKey™ and **HepKey Plus™** are colour coded: 10 **green**, 15 **blue**, 22 **purple** and 28mm **orange**.

Figure 15: **HepKey Plus™**

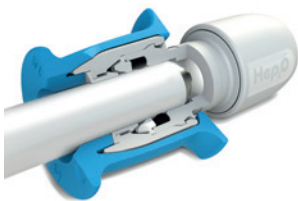

Figure 16: **HepTool™**



To use **HepKey Plus™**:

1. Place the HepKey Plus™ around the pipe.
2. Clip HepKey Plus™ over the fitting.
3. In this position it depresses the inner release ring of the fitting.
4. Withdraw the pipe from the fitting.

Basics

Hep₂O Push-fit Plumbing

Figure 19: Demounting sequence using **HepKey Plus™**



Step 1



Step 2



Step 3



Step 4

Figure 20: Cut-away drawing of **HepKey™**

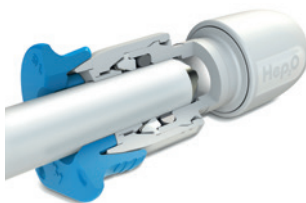

Note:

Before re-using the fitting we recommend applying a small amount of Jointing Lubricant Spray (code HX200) to the O-ring seal inside the fitting (see page 14).

To use **HepKey™**:

1. Clip the HepKey™ round the pipe next to the joint to be demounted, with the flat side of the HepKey™ away from the fitting.
2. Slide the HepKey™ up to the fitting and press so that the protruding 'lugs' depress the inner release ring of the fitting.
3. Withdraw the pipe from the fitting.

To use **HepTool™**:

1. Position the appropriate sized tool around the collar of the fitting.
2. Push down the release ring and pull out the pipe.

Hints and tips for trouble-free Hep₂O installation

These are simple and effective precautionary steps which should be taken to avoid problems and ensure trouble free installation of Hep₂O.

Hep₂O pipe

The biggest potential problem is damage to a pipe end, in the form of a deep scratch which can create a leak pathway for water to pass. Taking a few precautionary measures can eradicate any such problems:

- ⦿ Take care how and where the pipe is stored
- ⦿ Retain pipe in protective packaging until it is to be used
- ⦿ Never use an open bladed knife to remove the pipe packaging
- ⦿ In the case of coiled pipe, always use the shielded blade tool supplied (see Figure 21) to slit the packaging around the inside of the coil. This enables the pipe to be drawn from the inside. The packaging then serves to contain the coiled pipe until the last metre (see Figure 23)
- ⦿ When threading pipe through holes in stone, brick or block walls always use a pipe sleeve or a small piece of foam pipe insulation to protect the pipe from the rough surface
- ⦿ Ensure exposed first fix pipe ends are protected from damage by using a temporary end protector. This also ensures no debris will enter the pipe (see Figure 22)
- ⦿ Avoid kinking the pipe during installation

Figure 21: Unwrapping coil



Figure 22: Always protect pipe ends



Basics

Hep₂O Push-fit Plumbing

Figure 23: Packaging retains pipe until last metre



Hep₂O fittings

As the fitting cannot be taken apart few problems can arise but some basic precautions are advisable:

- ⦿ Avoid dust and debris entering the fitting
- ⦿ Store materials in a secure place free from dust and dirt etc.
- ⦿ Keep fittings in their bags until ready for use
- ⦿ When re-using a fitting, spray a little Hep2O HX200 Jointing Lubricant onto the O-ring (see Figure 9 on page 14).

Handling and storage

Hep₂O is an extremely tough and durable system. However, following the simple guidelines below will ensure its performance is not impaired by poor storage:

- ⦿ Straight lengths of Hep₂O pipe should be stored flat or stacked vertically
- ⦿ Coils may be laid on their side or edge
- ⦿ Pipe and fittings, wherever possible, should be stored in their original packaging
- ⦿ All Hep₂O pipe and fittings should be protected from contact with petroleum and oil derivatives
- ⦿ Do not expose to UV light for prolonged periods
- ⦿ Avoid dragging the pipe along the ground or on other surfaces such as walls
- ⦿ When feeding pipe through holes in walls and brickwork pipe ends should be taped over, or an end cap should be used. These precautions will protect the pipe end from damage and also prevent debris entering the pipe
- ⦿ Care should be taken to avoid kinking the pipe during installation

Colour-coded packaging

To make buying, handling, storing and installing the Hep₂O system as simple as possible, a colour-coded system has been introduced.

Hep₂O fittings are now supplied in sealed polythene bags colour-coded by size, which makes them easy to keep clean and easier to identify – you can see all the 15mm fittings at a glance – just look for the blue packs.

Just to make it easier still, the same colour-coded packaging has also been applied to Hep₂O pipe.

- ① 10mm: **green**
- ② 15mm: **blue**
- ③ 22mm: **purple**
- ④ 28mm: **orange**

No more searching the van to find those elusive 22mm elbows, just look for the purple bag!

Figure 24: Colour-coded packaging is designed to make product selection easier



Other Jointing Applications

Hep₂O Push-fit Plumbing

Connecting Hep₂O pipe to compression fittings

Hep₂O pipe is suitable for connecting to compression fittings which comply with BS EN 1254.

Cut the Hep₂O pipe with the recommended cutters and proceed as follows:

1. Cut pipe and insert a Hep₂O **SmartSleeve™** pipe support sleeve into the pipe end.
2. Apply PTFE tape if required.
3. Fully insert the pipe into the fitting.
4. Tighten nut, taking care not to over-tighten.

Figure 25: Procedure for connecting Hep₂O pipe to a compression fitting



Insert support sleeve into pipe



Apply PTFE tape if required



Ensure pipe is fully inserted

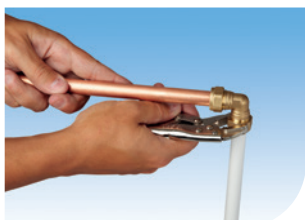

Tighten nut

Note:

- ⦿ Do not use oil based jointing compounds
- ⦿ Always use an appropriate SmartSleeve™ pipe support sleeve
- ⦿ Use copper olives in preference to brass
- ⦿ Hep₂O pipe will not rotate in a compression fitting after tightening

Hep₂O connections adjacent to capillary joints

When using Hep₂O pipe or fittings adjacent to capillary joints, soldering work should be carried out before the Hep₂O is installed. If this is not possible, keep any heat away from Hep₂O and observe the following precautions:

1. **Don't** allow Flux to run onto Hep₂O pipe or fittings. Flux runs inside the pipe may occur during soldering, this effect can be reduced by not using excessive amounts of Flux and by applying Flux to copper pipe end only.
2. **Don't** allow hot solder to come into contact with Hep₂O.
3. **Don't** allow Hep₂O to overheat. Wrap a damp cloth around copper pipe to minimise any likely heat transfer or use a heat absorbing gel.

Note: Systems should be flushed with water to remove any internal Flux residues.

Connection to chrome plated or stainless steel pipe

Hep₂O fittings cannot be connected directly to chrome plated copper or stainless steel, because of the relative surface hardness of these materials. The recommended method is to use compression fitting (see page 24).

Connection to brass spigots

The only brass spigots suitable for jointing into Hep₂O fittings are those included within the Hep₂O range. Brass spigots designed for compression or capillary joints do not have the necessary joint grooves and are too short.

Connection to earlier Hep₂O systems

Hep₂O is fully compatible with all current and earlier versions of Hep₂O fittings, including its immediate predecessor and the earlier Acorn[®] system manufactured by Bartol.

Other Jointing Applications

Hep₂O Push-fit Plumbing

Connecting Hep₂O fittings to other brands of pipe

Hep₂O fittings should not be used in conjunction with other manufacturers' plastic pipe and fittings, as dimensional tolerances and quality control cannot be guaranteed by Wavin.

Connecting Hep₂O to steel pipes and threaded bosses

In order to facilitate connection to male and female iron threads, four adaptors (HX28/HX29 socket adaptors) and (HX31/HX30 spigot adaptors) are available in the Hep₂O range. This enables connection to a wide range of different materials.

Installers are recommended to take note of the advice given in the foreword of EN 10226-2. Taking account of the variations which may be present in the mating threads, Wavin recommends the use of PTFE thread tape to ensure a reliable seal.

Figure 26: Hep₂O Adaptors



HX28 Socket adaptor



HX29 Socket adaptor



HX30 Spigot adaptor



HX31 Spigot adaptor

Connections to appliances using Hep₂O

When connecting to appliances and dishwashers always use Hep₂O appliance valves from the Hep₂O range (HX38/15). Adjacent Hep₂O pipework should be clipped in accordance with the recommended clipping distances using screw-type clips (HX85) (see pipe support - page 34).

Figure 27: Valves for connecting appliances



HX38/15 Appliance Valve

System alterations

Using a Blanking peg to seal off a fitting

When you need to provide a temporary or permanent seal to one of the ports on a Hep₂O fitting, insert a blanking plug (HX44) directly into the open connection. You can use **In4Sure™** joint recognition technology to check the plug is fully inserted. To remove the plug use a **HepKey™** or **HepKey Plus™** and continue with the installation.

Figure 28: Blanking peg shown on its own, and inserted into fitting



Other Jointing Applications

Hep₂O Push-fit Plumbing

System alterations continued

Using a stop end to seal off a pipe

When you need to close off the open end of a pipe, first fit a **SmartSleeve™** support sleeve in to the open pipe end then fit a stop end (HD62) onto the pipe to provide a temporary or permanent seal.

Figure 29: 15mm stop end



Just push to release –
no tools needed

Where it's OK to use Hep₂O

Hep₂O is suitable for most domestic and commercial hot/cold water and heating applications. A comprehensive range of fittings meets all today's requirements and provides secure connection and reliable operation. Providing installation work has been carried out using good plumbing practice as outlined in this guide, all Hep₂O pipe and fittings are guaranteed for 50 years under normal use.

Figure 30: New Hep₂O is now more compatible with modern sanitary ware



Where it's not OK to use Hep₂O

The Hep₂O system has been designed and tested to meet the requirements of modern heating and water distribution systems.

Testing has not been carried out to determine suitability for other purposes and therefore Hep₂O should not be used in the following applications:

- ⦿ Conveyance of gas
- ⦿ Conveyance of fuel oil
- ⦿ In areas contaminated by petroleum and oil derivatives
- ⦿ Conveyance of compressed air
- ⦿ Hep₂O is not suitable for use in systems where the water carried in the pipe contains a high concentration of chlorine e.g. swimming pools or decorative water features
- ⦿ Hep₂O will not be affected by those levels of chlorine expected in the UK water supply (typically less than 0.5ppm). Short term chlorination for disinfection will not have an adverse effect on the system (see page 62)
- ⦿ Hep₂O should not be used for the primary circuit of a Solar Heating System as temperature cannot be thermostatically controlled. Hep₂O is suitable for secondary circulation of these systems
- ⦿ Hep₂O should be protected at all times from exposure to direct sunlight and ultra violet light.
- ⦿ **Hep₂O should not be installed in Continuously operated re-circulating systems (Secondary Hot Water Circulation/ Ring main installations). Please see Important Information section on pages 60-61 for more details**

Sitework

Hep₂O Push-fit Plumbing

Cabling through joists

The Building Regulations Approved Document A allows for pipework to be installed in joists by either notching or drilling. The traditional method has been to notch the joists as the rigidity of the pipe does not easily allow for any other method of installation. However this has a number of disadvantages:

- ⦿ Pipework must be installed prior to the floorboards being laid
- ⦿ Plumber has to work on open joists increasing risk of accident
- ⦿ Need to return after floors are laid to connect radiators, etc.
- ⦿ Tails often moved by other tradesmen, causing extra work to reposition pipework correctly for radiators

Figure 31: Hep₂O speeds up installations because pipework can be easily cabled through drilled joists



The exceptional flexibility of Hep₂O pipe removes most of these restrictions by allowing pipe to be easily curved and 'cabled' through drilled joists, or I-beams which means:

- ⦿ Flooring can be laid prior to the plumber carcassing from below which will progress the building schedule as other trades can work on the floor above e.g. to form studwork etc.
- ⦿ Site safety enhanced as the plumber is not exposed to the danger of falling or the discomfort of kneeling on open joists
- ⦿ Other trades working below are protected from the dangers of falling tools, molten solder, gas bottles etc.
- ⦿ Carcassing at a later stage in the construction programme means the building is likely to be weatherproof
- ⦿ Less danger of puncturing the pipe with nails used for fixing the floorboards and no need to use protective devices such as 'joist clips'

It is worth noting that drilled holes in joists should be large enough to allow for thermal movement of the pipe.

Less risk to health and greater site safety

The unique Hep₂O system ensures:

- ① Effective, leak-free pipe jointing without the use of a naked flame
- ① No soldering means safety from fire, especially in restricted spaces
- ① Improved working environment
- ① No Flux or Solder eliminates potential contamination of water supplies

Hep₂O push-fit jointing also has the following advantages:

- ① No naked flame means that precautions such as obtaining a 'Hot Work' permit, having a fire extinguisher readily available, and remaining on site for a while after jointing, are not necessary
- ① No risk of infringement of Health and Safety recommendations applicable to some brands of Flux. e.g. means to control exposure to noxious fumes when working in a confined space, and use of eye protection (where appropriate)
- ① After jointing, the fitting is clean and safe to touch, e.g. after soldering, the joint is hot and Flux traces need to be removed
- ① Joint is rotatable after installation

Other system benefits include:

- ① Longer pipe runs and less joints, due to pipe flexibility
- ① Elimination of 'dry runs' as pipe can be cut and jointed in situ
- ① Absence of solvents means testing can be carried out as soon as installation is complete
- ① Tails for connection to sanitary ware can be left long enough for final connection, thus eliminating the need for straight and offset connectors as with rigid pipe systems
- ① Natural flexibility of the pipe helps overcome small misalignments

Sitework

Hep₂O Push-fit Plumbing

Cabling through joists continued

Drilling the floor joists

- ① Hole diameters should be no greater than 0.25 of the depth of the joist and should be drilled at the neutral axis
- ① They should be not less than 3 diameters (centre to centre) apart and should be located between 0.25 and 0.4 times the span from the support

Note: The Building Regulations Approved Document A gives exact instructions on the drilling of floor joists.

These points are illustrated (see Figure 32).

The value 0.25 is obviously one quarter and can easily be calculated on site. The value 0.4 is less obvious and can be obtained (see Figure 33).

Figure 32: Explanation of drilling joists in accordance with the Building Regulations Approved Document A

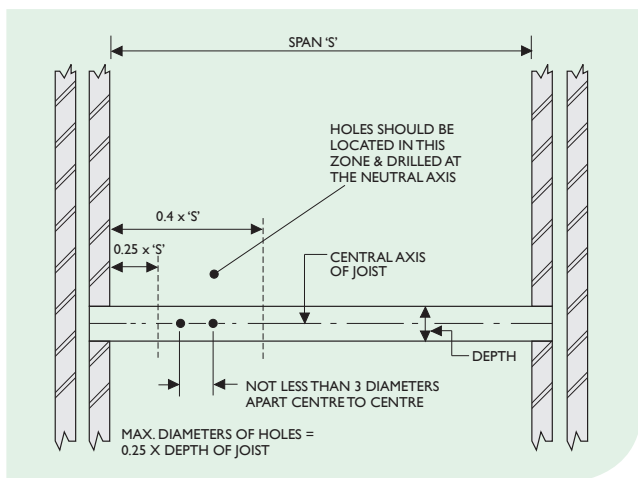

Note: The minimum distance between a hole and a notch in the same joist should not be less than 100mm.

Figure 33: Graph showing dimension of joist drilling zone from support

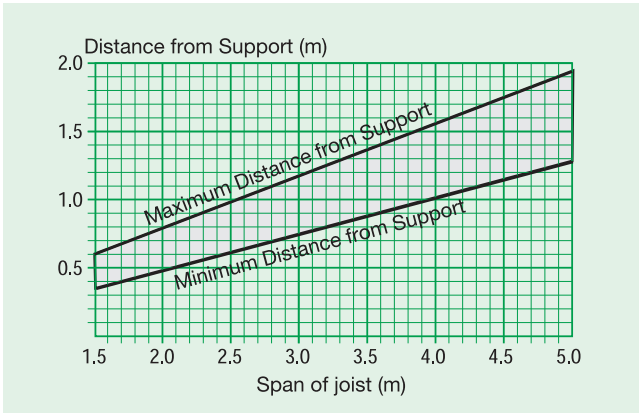

Note: This graph should be used in conjunction with Figure 32.
Example of use: Joist span is 4.5m. Find value on horizontal scale and read up to sloping line. Transfer point of intersection to the vertical scale and read 1.8m.

Engineered joists

Hep₂O is ideal in buildings incorporating timber 'I' joists. Piping can be properly installed through holes in the web section without damaging flange members (eg. TJI Joist system, Truss Joist MacMillan Ltd.) even where the preformed holes do not align on the plan.

Spigot tees and manifolds

The Hep₂O system incorporates a comprehensive range of spigot tees which can be used individually or in groups to give manifold arrangements with the benefit of 360° rotation. Alternatively, the system includes a selection of manifolds from single to four ports (see page 54).

Sitework Hep₂O Push-fit Plumbing

Connecting pumps, valves etc.

Where Hep₂O is connected to pumps, valves and similar devices consideration should be given to adequately supporting the item in question (bearing in mind the rotatability of the Hep₂O joint). Equipment should not be suspended from the pipe without adequate support.

Pipe support

The Hep₂O system includes two types of pipe clip – the screw fix type (HX85) and the nail type (HX65).

Figure 34: Pipe clips



Nail

Cat no	Nom dia (mm)
HX65/10	10
HX65/15	15
HX65/22	22
HX65/28	28



Screw

Cat no	Nom dia (mm)
HX85/15	15
HX85/22	22
HX85/28	28



Spacer

Cat no	Nom dia (mm)
HX86/15	15
HX86/22	22

Note: The HX86/22 spacer can be used with both the HX85/22 and HX85/28 clip.

The nail type is designed for use on concealed pipework for rapid fixing to timber. The screw type may be used together with a spacer (HX86) to allow greater spacing between the pipe and the fixing background. The spacer therefore allows different pipe fixing centres which can be used to facilitate pipe cross-overs or fitting of thermal insulation to the pipe.

Figure 35: Pipe fixing centres

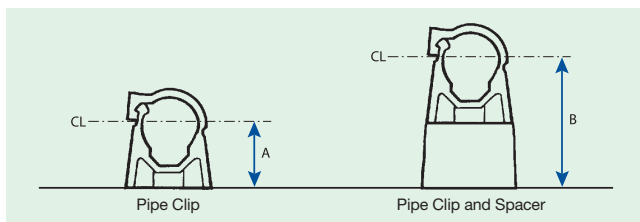

Note: Fixing hole size is 5mm diameter.

Nominal diameter (mm)	Dimension A (mm)	Dimension B (mm)
15	17	40
22	21	43
28	24	46

A cold forming bend fixture (HX75) is also available to allow the formation of a bend on 15mm and 22mm pipes for situations where secure fixing and neatness are important.

Figure 36: Cold forming bend fixture radii

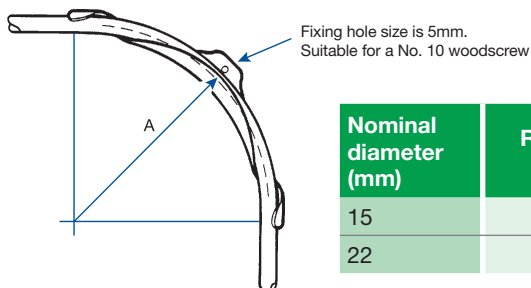

Nominal diameter (mm)	Radius A (mm)
15	120
22	176

Sitework Hep₂O Push-fit Plumbing

Cable ties

When pipe is concealed, cable ties may be used for support instead of clips. However these should not be over-tightened. The pipe should be allowed to slide freely to allow for thermal movement.

Pipe support distances

We recommend the use of pipe clips both to support the pipe and give a neat finish. The recommended support distances for general purpose use are shown in Table No. 3.

Where piping is adequately supported (e.g. through suspended timber floors) clips can be reduced or omitted provided that:

- ③ Pipe does not form part of an open vent provided for safe operation of a heat source
- ③ Pipe does not form a distribution pipe or circuit where effective air venting might be impaired by poor pipe alignment
- ③ Hot pipe will not come into contact with cold pipe or vice versa
- ③ There is no risk that pipes or fittings will come in contact with sharp, abrasive or other potentially damaging surfaces
- ③ There is no risk pipe will come in contact with materials which may be affected by transmitted heat

Where pipe is visible, a support distance between fixings of 300mm is suggested.

Where provision has been made for electrical wiring, such as in some partition systems, this can often be utilised for Hep₂O pipework.

Table 3: Recommended Clipping Distance

Nom dia (mm)	Horizontal runs (m)	Vertical runs (m)
10	0.3	0.5
15	0.3	0.5
22	0.5	0.8
28	0.8	1.0

Figure 37: Minimum bending radii (8x pipe diameter)

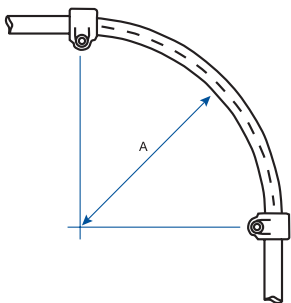

Nom dia (mm)	A (mm)
10	80
15	120
16	128
20	160
22	176
28	224

Figure 34 shows a cold formed bend fixture (HX75). This is suitable for use with 15mm or 22mm where secure fixing and neatness are important.

Hep₂O pipe can easily be manipulated by hand to form bends of any angle. In order to prevent any long term detrimental effect on the material, the curvature of Hep₂O pipe should be not less than that shown. A bending radius of 8x the pipe diameter is the minimum allowed.

Pipework installation

Hep₂O fittings are now much sleeker and more stylish than previously, making them a lot more acceptable for exposed locations. However, Hep₂O pipe expands as temperature increases, causing it to undulate along its length and this effect is sometimes exacerbated where it is 'cabled' through joists. This will not create airlocks or have any other adverse effect on the operation of the plumbed system.

Concealed locations

Hep₂O pipe is relatively easy to install in concealed locations in floors, roof spaces etc. Any expansion in the pipe will have little mechanical effect, this being absorbed within the pipe length so undulation can be ignored. Installation in difficult locations is aided by the cabling ability of Hep₂O pipe. If adequately supported, Hep₂O pipe in concealed locations need only be clipped for system alignment e.g. at changes in direction. If preferred, cable ties can be used in such areas.

Sitework

Hep₂O Push-fit Plumbing

Use of metal tape to aid 'electronic' pipe detection

The NHBC Standards includes a section which affects the installation of pipework in walls. It states:

'Where pipework is in or behind wall surfaces, and would otherwise not be detected by a metal detector or similar equipment, a metallic tape should be applied to the pipework'.

The NHBC has agreed that other methods of installing tape are also acceptable, as any tape applied to plastic pipe or fittings will require testing to ensure compatibility with the pipe and ensure the adhesive will not pass through the pipe and taint the water.

Note: Metallic tape with an adhesive backing should NOT be applied directly to Hep₂O pipe and fittings, but the following methods of aiding detection are allowed:

Metallic tape without adhesive can be lightly crimped around the pipe to allow detection by an electronic pipe detector or, adhesive metallic tape can be stuck to the backing wall as close as possible to the pipe run.

Figure 38: Metallic tape can be used to aid electronic pipe detection



Note: Self adhesive information labels should not be applied directly to Hep₂O pipes and fittings, they must be placed on suitable surfaces adjacent to the pipe run.

Pipes through walls and floors

Wherever Hep₂O pipe passes through brickwork, stone or concrete it should be sleeved. The annular gap between the pipe and the sleeve should be filled with a resilient material to provide an effective fire stop and also prevent the transmission of noise from one room to another.

Expanding foam, in its initial wet state, must not come into contact with the Hep₂O pipe as it can cause an adverse chemical reaction whilst drying. The use of a pipe sleeve will provide the necessary protection.

Laying pipe in floor screeds

Unlike metal pipes, Hep₂O is not affected by the corrosive effects of cement, lime, mortar or concrete. However, account should be taken of the Water Byelaws which requires distribution pipework to be accessible to facilitate its removal and replacement (see page 40 Hep₂O Conduit system).

Pipes adjacent to metalwork

When running Hep₂O adjacent to or 'through' metalwork, it is important to ensure that the pipe doesn't come into contact with any sharp edges as any subsequent thermal movement could cause damage.

The following cautionary measures should be observed:

- ① Where pipe passes through a small drilled hole, fit a suitable grommet
- ① Where pipe passes through a large hole in metalwork or adjacent to a sharp edge, fix an extruded flexible profile to the metalwork
- ① Provide adequate pipe clips or cable ties to prevent abrasive contact between pipe and metalwork
- ① Run the pipe within a conduit

Sitework

Hep₂O Push-fit Plumbing

Hep₂O pipe means quieter operation because there's less noise...

Problems with noise are often found in systems which incorporate rigid pipes. Hep₂O pipe does not transmit noise and with careful installation, can be installed to run almost silently.

...from friction

Noise can be caused by friction between a pipe and adjacent surfaces – typically where rigid pipes are installed beneath timber or chipboard flooring.

Hep₂O can greatly reduce this effect. Where holes are drilled through joists they should be of sufficient diameter to allow Hep₂O pipe to slide freely (see page 30). This will prevent any friction between the underside of a floor, and more importantly, it will avoid the 'ticking' and creaking normally associated with the thermal movement of rigid pipes.

...from knocking

Noise can be caused by rigid pipes knocking together or knocking on adjacent surfaces. Hep₂O's inherent elasticity cushions such impact, causing less impact noise and absorbing vibration, thus preventing the transmission of sound along the pipe.

...and from 'water hammer'

Similarly noise from 'water hammer' resulting from abrupt stoppage of water flow (typically by closure of quarter turn valves, solenoids and reverberating ball valves). Such noise is normally absorbed by Hep₂O and is not transmitted along the pipes.

Installing pipes in concrete floors or walls

Hep₂O Conduit system

The Hep₂O Conduit system allows pipe and fittings to be installed directly into concrete floors or into walls whilst complying with the requirements of the Water Regulations.

The flexible conduit allows Hep₂O pipe to be easily withdrawn for inspection, and junction boxes allow maximum accessibility to fittings for inspection and possible removal.

If any bent sections of conduit pipe are formed in an installation then future replacement of the Hep₂O is likely to require the use of a 'draw cable'. This requires a cable to be attached to one end of the Hep₂O pipe before it is pulled out of the conduit from the other end. The draw cable remains in the conduit. Subsequent replacement of a new section of Hep₂O pipe may require two operatives; one pulling the draw cable which is attached to the pipe end, and the other person feeding-in the new length from the opposite end. Future replacement will be easier if conduit bends are kept to a minimum and any radius kept as large as practicable. See also 'Fitting the conduit', later in this section.

The system is available in all diameters, together with junction boxes with lids and terminal fittings.

Holes can be cut in the sides of the junction box at the appropriate position to accommodate the conduit which simply clicks into position.

Installation

The Hep₂O pipe should be fed into position at the same time as the conduit system is installed, i.e. before screeding. The conduit system should not be installed on sub-floors a long time in advance of screeding as damage by site traffic could occur. The junction box allows access to pipe fittings, and also allows pipe cross-overs (which are normally undesirable within the floor screed material). Dimensions are shown (see Figure 41).

Figure 39: Conduit junction box

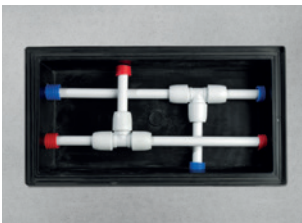

Figure 40: Cut conduit box for wall termination



Sitework Hep₂O Push-fit Plumbing

Installation continued

The conduit pipe should be fixed to the sub-floor using suitable straps to prevent movement. Conduit pipes for cold water systems should not be run in floor screeds which incorporate underfloor heating loops. If required the junction box can be cut in half and installed up against a wall (see Figure 40).

Figure 41: Junction box dimensions

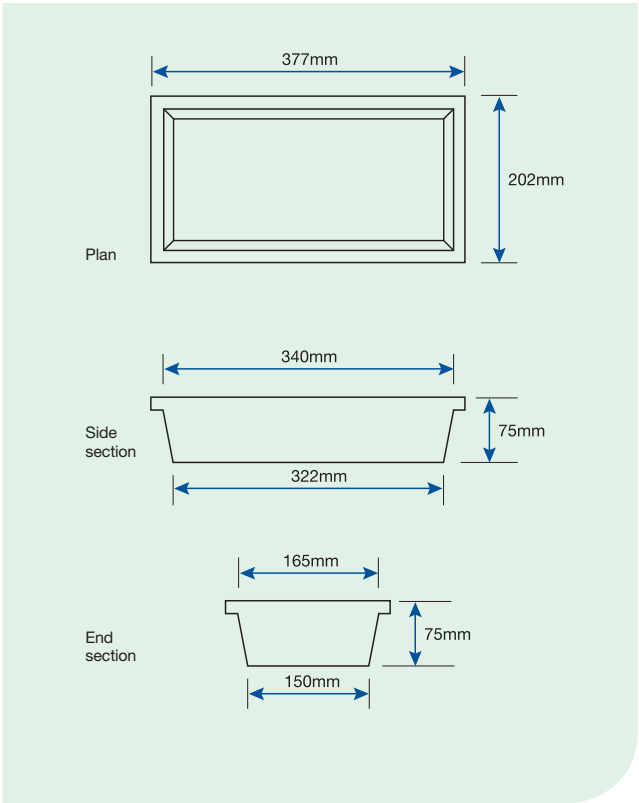
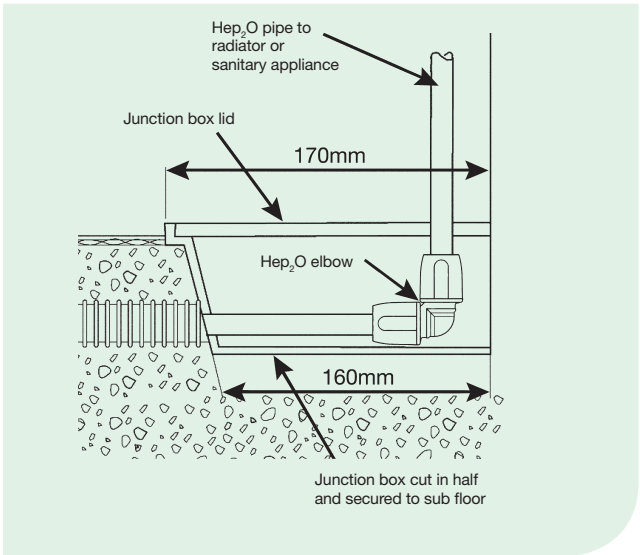

Figure 42: Cut junction box



The junction box should be drilled using a hole cutter or spade bit, to allow the conduit to fit snugly and click into position.

It should protrude at least 5mm inside the box. Hole sizes and conduit OD's are shown in Table No. 4.

Table 4: Drill size for conduit box holes

Hep ₂ O size (mm)	Conduit Cat no	Conduit OD (mm)
10 & 15	HXC25/15 - HXC50/15 - HXXC50/10 - HXXC50/15	25
22	HXC25/22 - HXC50/22 - HXXC50/22	34
28	HXXC25/28	42

Note: Central heating pipework should not be run within the same junction box as cold water pipework unless there is space to fix adequate thermal insulation to prevent the warming of the cold water. The prevention of cold water becoming warm is a Water Regulations requirement.

Sitework Hep₂O Push-fit Plumbing

Fitting a junction box

The junction box should be fixed to the sub-floor to prevent movement during screeding. Fixings with suitable washers should be used and the box should be positioned so that the lid (when fitted) will be level with the adjacent final floor finish.

If the required screed depth exceeds that of the junction box, suitable packing should be placed under the base. However, if the junction box is to be installed into insulation, there is no effective method of holding the box down, so double sided adhesive tape should be used.

Figure 43: Hot and cold water distribution pipes at tees

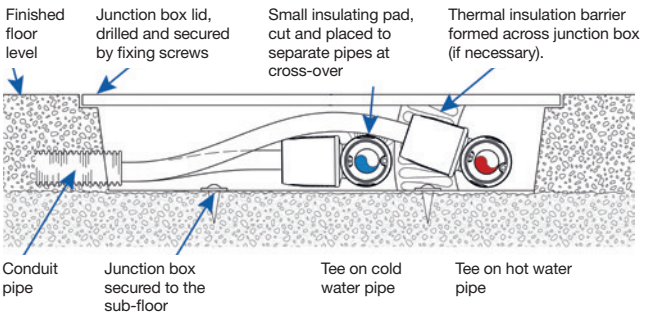

Note: Thermal pipe insulation is not necessary when the junction box is used solely for central heating pipes.

Fitting pipe into conduit

To facilitate the possible removal and replacement of Hep₂O, the conduit should be installed without joints and should ideally run in straight lines between junction boxes. Where bends are unavoidable, there should not be more than two changes of direction between adjacent junction boxes:

- ③ Conduit carrying cold water pipes should not touch conduit carrying hot water or central heating pipes
- ③ When running conduit within floor screeds the recommended gap between hot and cold should not be less than 50mm in order to prevent the warming of cold water (see Figure 44).
- ③ The conduit system should not contain unused water pipes which remain connected to water systems. Redundant pipework will result in water stagnation which would pose a risk to health

Figure 44: Spacing for cold water conduit in floor screeds

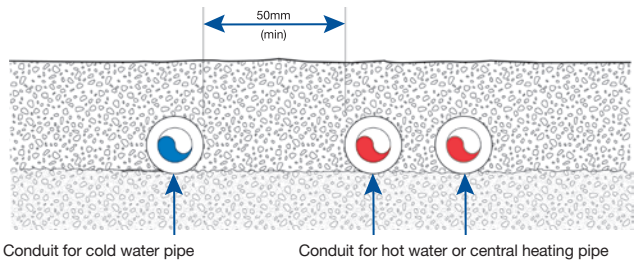

Sitework Hep₂O Push-fit Plumbing

Terminating the conduit

For terminating the conduit pipe at wall and floor finish level for direct 15mm connections to appliances, a conduit terminal fitting is available (HX101/15). For floor terminations the plastic housing may be drilled through the base to allow fixing. Floor termination procedure (see Figure 47).

Figure 45: HX101/15
15mm conduit terminal



Figure 46: HX103 terminal
back plate



Figure 47: HX101/15 conduit terminal installation procedure



Terminating the conduit continued

Figure 48: HX101/15, 15mm conduit terminal and HX103 terminal back plate

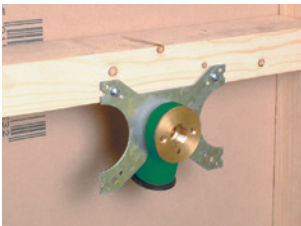

Figure 49: HX103, terminal back plate and HX6/15 wall plate elbow



For wall terminations the HX103 terminal back plate can be used to mount two terminals side by side (see Figures. 46 and 48) or it can be easily split to form two single plates. The same terminal back plate can also be used to fix a maximum of four wall plate elbows (see Figure 49). Installers are recommended to take note of the advice given in the foreword of EN 10226-2. Taking account of the variations which may be present in the mating threads, Wavin recommends the use of PTFE thread tape to ensure a reliable seal.

Figure 50: Installation of HX102 terminal fitting plate and HX101/15, 15mm conduit terminal



Sitework

Hep₂O Push-fit Plumbing

Hep₂O Pipe-in-Pipe system

This consists of Hep₂O Barrier pipe (see page 9) pre-sheathed in conduit ready for underscreed installation. This saves time and effort whilst complying with the current regulations. Hep₂O Pipe-in-Pipe is available in manageable coil lengths, and the conduit is available in red and blue to aid identification.

Figure 51: Hep₂O Pipe-in-Pipe is supplied in coils with a choice of red or blue conduit



Heating Systems

Hep₂O Push-fit Plumbing

Dry lined wall feeds for radiators

There are distinct advantages to using 10mm Hep₂O pipe instead of microbore copper feeds to radiators. Hep₂O pipe can easily be accommodated behind 'dot and dab' plasterboard (see Hep₂O within internal drywall system on page 56) to give a pipe-free appearance within a room, but unlike copper, it is not susceptible to damage such as dents or kinks which can be caused on 'soft' copper by other follow-on trades.

Figure 52: Radiator pipework in 10mm Hep₂O within dry lined walls

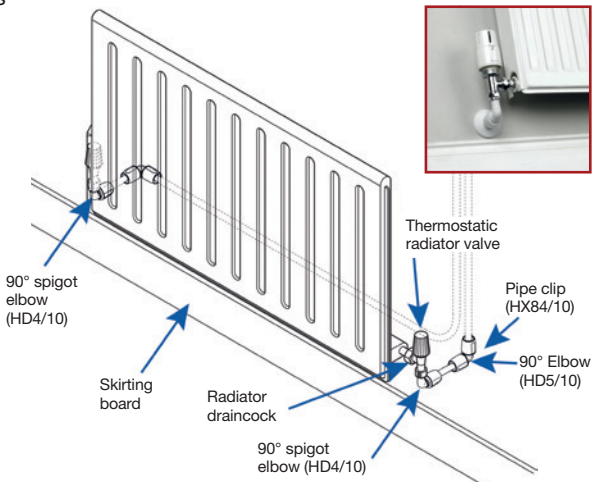

Radiator outlet cover plate

A neat solution when using 10mm Hep₂O pipe, is to utilise the HX113 Hep₂O Radiator Outlet Cover Plate. This cover plate, fitted in conjunction with a back box provides an exceptionally neat and easy to install method of connecting radiators. It also has the benefit of a hinged flap that provides an airtight seal.

The box is fixed in a central position behind the radiator with the 10mm pipes dropping out to the radiator valves. This gives a smart professional finish where little or no pipe is seen and for new build provides an anchor point for the pipework prior to plastering/boarding (see Figure 53 on page 50).

Heating Systems

Hep₂O Push-fit Plumbing

Figure 53: Installation procedure of HX113 cover plate



1. Position back box centrally behind radiator location with adequate pipe for left or right connection



2. Fit cover plate which provides an airtight seal when closed



3. Pipework can now be left until follow-on trades have finished working



4. The result leaves little or no pipe on show

First-fix radiator feeds

The following is good practice for first-fix pipework:

- ⌚ For conventional connections to radiators, the pipe drops should run vertically, side by side at one end of the radiator position
- ⌚ Where a radiator outlet cover plate is used, the radiator drops should run vertically, side by side, to the centre of the radiator position
- ⌚ Lateral pipes should be run horizontally through the stud work, avoiding any obvious fixing zones such as skirting boards

Note: Where subsequent wall fixings are likely, metallic tape should be used to enable an electronic pipe detector to be used (see page 38).

For fixing pipework to lightweight blockwork, use wooden dowels at each clip position. The HX65 pipe clip is not suitable for fixing directly to such walls because of the low pull-out resistance of the nail.

Connecting Hep₂O pipe to storage vessels and radiators

Hep₂O pipe is compatible with most other makes of fittings, but when connecting it to cylinders, radiators etc. Hep₂O fittings should be used wherever possible. If an appropriate fitting is not available from the Hep₂O range, a recognised brand should be used.

The Hep₂O range includes double check valves, tank connectors, gate valves, stopcocks and cylinder connectors.

If the use of compression fittings is unavoidable then the jointing instructions outlined in the section, 'Connection Using Compression Fittings' (see page 24) should be carefully followed.

Also:

- ⓘ **Do not** use any jointing compound on the jointing shoulder of the cylinder connector, use only PTFE tape
- ⓘ **Do not** use any jointing compound when fitting tank connectors, use only sealing washers

Figure 54: Hep₂O tank connector



Heating Systems

Hep₂O Push-fit Plumbing

Connecting Hep₂O to ancillaries (pumps, valves, etc.)

When connecting Hep₂O to ancillary items, it is important to follow the guidance in the section 'Connections Using Compression Fittings' (see page 24).

Hep₂O pipework must be clipped adjacent to the outlets of the pumps and valves using Hep₂O screw pipe clips (code HX85). This ensures adequate support and reduces vibration in the majority of cases. Where it is felt that the weight of the connected equipment merits extra support, metal brackets should be used. Where the size of the pump and/or valve requires fixing at a greater distance from the wall than can be accommodated by the pipe clip alone, this can be augmented with a pipe spacer (HX86). This will allow a greater 'stand-off' distance whilst maintaining security.

Connecting boilers and heaters

Where boilers incorporate a high limit cut out thermostat, pump overrun device and have connections outside the boiler casing 350mm from the heat source, direct connection can be made using Hep₂O. Typically these boilers contain a copper heat exchanger and are low water content boilers.

Where the above criteria for direct connection to a boiler cannot be met a minimum one metre run of copper pipe should be installed between the boiler and the start of the Hep₂O system.

Note: Where individual boiler manufacturers instructions state differently, they should always be followed.

In all cases including instantaneous water heaters, caravan heaters etc. care must be taken to ensure that appliances have the appropriate thermostatic controls and cut outs to ensure that operating conditions do not exceed the temperature and pressure limits laid down for Class S pipe.

(see Table No.1 - page 9).

Connecting boilers and heaters continued

For any type of back boiler, all the water connections should be extended from the appliance to the outside of the fireplace opening using copper pipe.

Any gravity circuit of a solid fuel boiler should always be installed in copper. Regulations require that metal pipe be used as the discharge pipe from temperature/pressure relief valves on unvented water heaters, to or from a tundish, or from safety valves on sealed central heating system. On sealed systems where the safety valve is not provided within the boiler casing, the pipe between the safety valve and the boiler should be in copper. All boiler connections should be made in accordance with the requirements of BS 5955, part 8.

Note: During commissioning it is important to ensure that all trapped air is purged from the heating system before the boiler is operated. 'Pockets' of air can effect proper circulation and impair the correct operation of boiler temperature controls, and this can cause severe overheating.

Manifolds

Hep₂O 10mm manifolds are particularly suited to microbore plumbing and are available in 2 and 4 port versions. They are designed primarily for use in central heating systems but can also be used for hot and cold water supplies. Hep₂O 15mm manifolds are available in 2 and 3 port versions.

A Hep₂O manifold is a single fitting which brings together multiples of 10mm or 15mm pipe, on the flow or return pipework, to one area of a building, enabling easy access.

A comprehensive range of Hep₂O manifolds is available, and these can be connected in series to allow any number of outlets. Alternatively, a range of 'spigot tee' fittings can be coupled together to give independent 360° joint rotation.

Heating Systems

Hep₂O Push-fit Plumbing

Figure 55: Hep₂O manifolds are used to connect multiples of 10mm or 15mm pipe

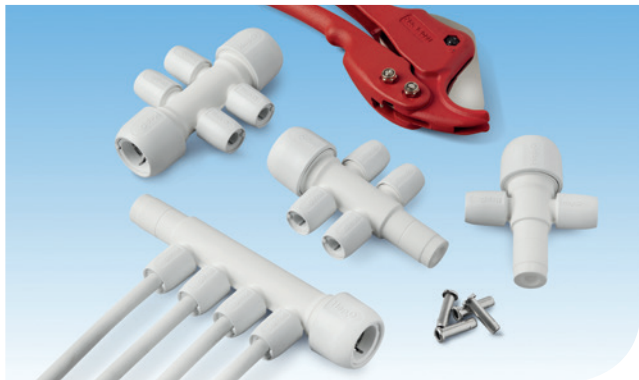

Cutting a manifold spigot end

If you want to continue on from a manifold, the spigot end can be removed to allow you to extend with further fittings.

Figure 56: Cutting a manifold spigot end



Installation and performance benefits

- ① Choice of 2, 3 or 4 port manifolds reduce the number of fittings required to connect 22mm pipe to 10mm or 15mm pipe
- ① Manifolds reduce the number of fittings required and cut installation time
- ① Manufactured from Polybutylene, an extremely robust yet lightweight material, they are easy to install
- ① Lightweight Polybutylene manifolds enable pipe to be suspended between joists without fear of it being dragged down
- ① Hep₂O blanking pegs can be used to close off any unused sockets

Hep₂O within internal drywall systems

The Hep₂O system can easily be cabled within timber studwork and within wall systems (eg. Paramount Board) during construction. This method is often used for running feeds to radiators or where concealed plumbing is necessary, e.g. supplies to a recessed shower mixer.

A connection for a radiator can be made by using a secured elbow in the wall and fixing a plastic snap-on escutcheon to neatly cover the hole through the wall surface.

Alternatively for 10mm Hep₂O a dry lining box can be used which gives the advantage of allowing minor alignment adjustment to the 'tail' during 'second-fix' (see Figure 57) and allowing access to the elbow. 'First-fix' pipework should follow the good practice advice in the text headed 'Dry lined wall feeds to radiators' described above, and 'pipes adjacent to metalwork' (see page 39).

Heating Systems Hep₂O Push-fit Plumbing

Figure 57: Radiator connection using 10mm Hep₂O and a dry lining box within a drywall

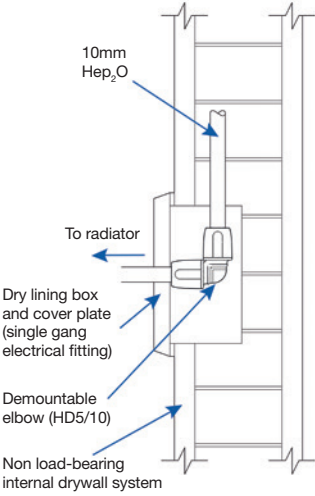

Note: This solution can also be used where the radiator is fed from below in which case the risers should be located directly under each box.

Hep₂O within timber framed and steel framed buildings

The Hep₂O system is ideal for use within both timber framed and steel framed buildings but consideration must be given to:

1. Early detection of leaks which could damage the building fabric if left unattended. Resultant repair delays would also contravene Water Bylaws.
2. Installation of the pipework which should be on the warm side of any thermal insulation layer. It must also be possible to replace any pipes which pass through vapour control layers without affecting the integrity of the layer.

To comply with the above, pipework should either be run within a recessed duct designed by the architect, or run within a conduit system. Whichever method is used it is necessary to consider the detail at the junction between the wall and floor to avoid floor joist problems and to agree pipe penetrations at header rails/ bottom rails. For radiator connections, 10mm Hep₂O within conduit pipe may be used (see Figure 58).

Figure 58: Radiator connection using 10mm Hep₂O within timber or steel framed external wall

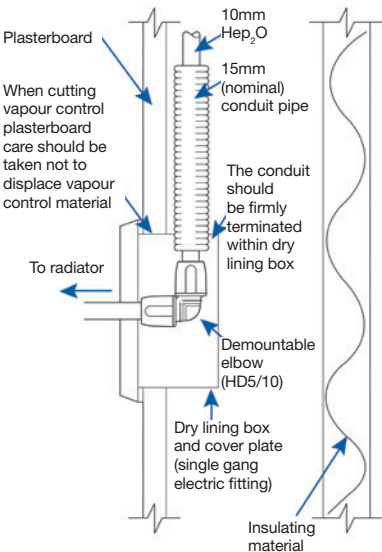

Heating Systems

Hep₂O Push-fit Plumbing

General advice

- ⌚ For drilling holes through timber joists (see Figures 32 and 33)
- ⌚ Within steel framed buildings, pipework should be routed through preformed holes in steelwork wherever practicable. No holes should be formed in steelwork without the approval of the architect. See text headed 'Pipes adjacent to metalwork' (see page 39)
- ⌚ Do not lay pipework in areas where plasterboard is likely to be fixed
- ⌚ Care should be taken to ensure pipework located within compartments or passing through party walls or floors does not impair the fire rating of the building

Figure 59: Installation is quicker and easier due to the flexibility of the Hep₂O system



Important Information

Hep₂O Push-fit Plumbing

Continuously operated re-circulating systems (Secondary Hot Water Circulation / Ring main installations)

A continuously operated re-circulating system is a water-replenished circulating system which is maintained at a constant high temperature to provide a constant source of hot water.

Continuously operated re-circulating systems are used to distribute constant hot water to draw off points that may be distant from the heat source or hot water storage vessel.

Continuously operated re-circulating systems are very different from conventional hot water supply and central heating systems found in domestic properties, for which our products have been tested to, under either BS 7291 2010 Class S or WRAS approval standards, and for this reason Hep₂O products must NOT be used on any continuously operated re-circulating systems as they are not approved under the current version of these standards.

Freezing for maintenance/system modification

Hep₂O pipe can be frozen for maintenance/repairs without damage to the system. When freezing equipment, manufacturers' instructions should be followed. Always freeze at a reasonable distance from where pipe is to be cut.

Painting Hep₂O

Hep₂O can be painted. In fact, painting is strongly advised for outdoor applications to protect the pipe from the effects of sunlight and ultra violet light. Painting with emulsion paint is preferred but oil based gloss paint can also be used in conjunction with undercoat. Before painting, ensure all surfaces are clean, free of grease and dry. Cellulose based paints, paint strippers or thinners must not be used.

Important Information

Hep₂O Push-fit Plumbing

Use of corrosion inhibitors

Corrosion of metals is a hazard in all installations therefore it is essential that possible causes of corrosion are kept to a minimum.

To provide maximum system protection, independent of pipe material, all heating circuits should be protected using an inhibitor. Fernox and Sentinel have been tested and are suitable for use with Hep₂O pipe and fittings.

Oxygen will almost always be present in any system as it can enter through a variety of points. Hep₂O Barrier pipe incorporates an additional oxygen barrier to reduce the ingress of oxygen through the pipe wall. It is accepted by British Gas and is suitable for use in heating systems which specify SuperWarm, GasWarm or are covered by British Gas Contract Service.

Antifreeze

Antifreezes based on Ethylene Glycol mixtures will not have any adverse effect on Hep₂O, however if there is any doubt, please contact our Technical Advisory Service – Tel: 0844 856 5165.

Electrical safety

Hep₂O does not conduct electricity therefore there is no risk of electric shock, and the practice of utilising metal pipework system for earthing was discontinued in 1966.

However, if Hep₂O forms a break in the continuity of existing metal pipework which may have been used for earthing or bonding, the electrical continuity must be reinstated by fixing the bonding lead permanently to both ends of the existing metal pipework. For further information contact the Technical Advisory Service – Tel: 0844 856 5165, or for information on electrical safety and the IEE regulations, contact a registered electrical contractor or your local electricity provider.

Equipotential bonding

A Hep₂O installation requires no more and in many cases needs less equipotential bonding than metal pipework.

Woodworm / timber treatment

When treating timber for woodworm or rot, aqueous based solutions are generally accepted, and it is preferable to carry out any such spraying prior to Hep₂O being installed.

Where this is not practical, care should be taken to protect and cover Hep₂O pipe and fittings prior to any spraying.

Please note that solvent based treatments should not be used. For further information contact the Technical Advisory Service – Tel: 0844 856 5165.

Precautions

Hep₂O Push-fit Plumbing

External installations

If Hep₂O is installed outdoors or in an unheated environment, it should be protected from frost in accordance with BS 5422, BS 6700 and BS EN 806, Water Bylaws and Building Regulations Approved Document L.

Hep₂O should be protected from the effects of ultraviolet radiation. If insulation has been installed to avoid freezing this provides adequate protection. Where insulation is not used, painting or covering is recommended.

Vermin

Testing has demonstrated that vermin do not show a preference for Hep₂O over other materials. However, all items which are softer than rodents' teeth are liable to be gnawed in vermin infested property. If vermin infestation is suspected, a reputable rodent exterminator should be consulted. If vermin are present they may damage Hep₂O pipework.

Chlorine

Hep₂O will not be affected by the levels of chlorine expected in the UK water supply (typically less than 0.5ppm), nor will short term chlorination for disinfection have an adverse effect on the system.

However, high sustained concentrations of chlorine will have an adverse effect on plastic pipe. Hep₂O is therefore not suitable for use in systems where the water contains a high concentration of chlorine e.g. swimming pools or decorative water features.

Testing Hep₂O Push-fit Plumbing

Pressure testing

When testing Hep₂O pipework systems, the recommended high pressure test is 1.5 times working pressure.

If the system contains ANY earlier version grab-ring or SlimLine fitting, a further test to a maximum of 18 bar should always be undertaken, but any non-Hep₂O appliances or fittings that will not withstand testing at 18 bar should be disconnected – check with other manufacturers instructions.

Figure 60: Pressure testing



Note: Pressure testing is NOT a substitute for making sure the pipe has been correctly inserted into the Hep₂O fittings. This should be achieved by following the correct jointing procedure and wherever possible, checking the joints using Hep₂O joint recognition technology as detailed (see page 18).

Figure 61: Test procedure

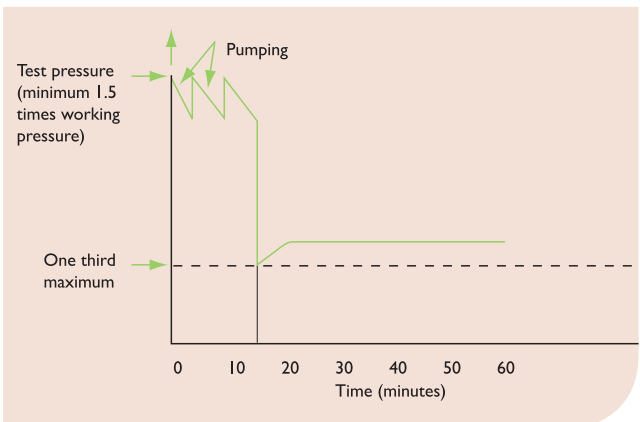

Testing Hep₂O Push-fit Plumbing

Test procedure

The recommended procedure is outlined below and both tests should be carried out with a low pressure test being followed with a high pressure test.

Low Pressure Leakage Test

The system shall be filled slowly with drinking water to allow air to be expelled from the system. The pressure in the system should be raised (or lowered) to between 0.5 Bar and 1 Bar. The complete installation shall be inspected for leaks at this pressure prior to the high pressure hydraulic test. There shall be no visible leakage of water and the pressure should be maintained for 45 minutes.

High Pressure Hydraulic Test

The installation shall then be tested hydraulically by subjecting the pipes, pipe fittings and connected appliances to a test pressure of not less than 1.5 times the maximum working pressure in accordance with the test procedure below. The maximum working pressure is defined as the maximum pressure that the system will operate at, measured as the incoming mains pressure (usually no more than 3 Bar if a pressure reducing valve is fitted). Maximum incoming mains pressure should not usually exceed 10 Bar. There shall be no visible leakage of water and the pressure shall be maintained for 45 minutes.

Test Procedure

1. Apply the required test pressure (1.5 times maximum working pressure) by pumping in accordance with fig 61, for a period of at least 15 minutes. Inspect the pipework to identify any visible leaks in the system.
2. Reduce the pressure in the pipework by bleeding water from the system to one third of maximum working pressure.
3. Close the bleed valve. If the pressure remains at or greater than, one third of the maximum working pressure the system is regarded as leak tight. Visually check for leakage and monitor for 45 minutes. The test criteria are met if there is no reduction in pressure.
4. Complete a test record sheet.

Special Applications

Hep₂O Push-fit Plumbing

Boats

Hep₂O is resistant to corrosion and light in weight. This makes it ideally suited to marine applications.

The flexibility of Hep₂O pipe means it can be cabled around the interior cavities of boats and easily hidden behind bulkheads. The mechanical flexibility of the Hep₂O system also allows it to absorb vibrations from the engine and forces of the sea which may cause soldered or compression joints to crack or work themselves loose. Hep₂O is impervious to electrolytic corrosion and performance is further assured through jointing technology which carries a 50 year guarantee.

Caravans

Hep₂O is ideal for caravans where its lightness and flexibility allows fitting in confined spaces without damage to the fabric of the vehicle, or adding unduly to the kerbside weight. Resistance to corrosion and freezing make Hep₂O an obvious choice for this application.

Exhibitions

Easy to install and dismantle, Hep₂O provides an ideal solution. The temporary nature of exhibitions combined with the requirement that services be run for considerable distances with multiple take-off points, requires a plumbing system which is flexible and capable of regular dismantling and re-installing to different layouts. A Hep₂O system answers all the requirements for flexibility and economy.

Portable buildings, site cabins, toilets etc.

The Hep₂O range includes all the necessary items to ensure compliance with local Water Bylaws (e.g. double check valves) whilst allowing the building to be moved to another location when required, with the minimum disruption to internal systems. Hep₂O is the ideal choice for these structures.

Special Applications

Hep₂O Push-fit Plumbing

Agriculture and horticulture

Inherent durability and resistance to corrosion and cold weather make Hep₂O ideal for many applications in agricultural and horticultural environments. Typical applications include water supplies to milking parlours, drinking troughs and horticultural watering systems.

Fault Finding

Hep₂O Push-fit Plumbing

In the unlikely event of a problem occurring, the following notes will help to identify the cause:

Typical Problems

1. Joint weeps

Probable causes:

- ⦿ Deeply scored or scratched pipe
Evidence: Visual inspection of pipe
- ⦿ Pipe has been inserted through grab-ring but not through O-ring
Evidence: Joint leaks but pipe remains in fitting
- ⦿ Dust or burrs under O-ring seal (usually occurs if a hacksaw has been used to cut the pipe)
Evidence: Contamination evident on visual examination of components
- ⦿ O-ring seal has been damaged, usually by the insertion of a sharp ended copper pipe), or the pipe support sleeve has been omitted
Evidence: Cause evident on visual examination of the component
- ⦿ Fitting may have been connected to old Imperial copper
Evidence: Measurement of pipe will reveal discrepancy with current standard diameter (BS 2871 Part: 1 1971)

2. Split fittings

Probable cause:

- ⦿ Formation of ice within a system containing metal pipework, or adjacent to metal taps
Evidence: Splitting

Note: Water freezes at 0°C and increases 9% in volume. Hep₂O pipe can absorb this volume increase without rupture, but if metal pipe or components are involved in the system, the extra pressure generated may occasionally be sufficient to split the fitting.

Fault Finding

Hep₂O Push-fit Plumbing

3. Pipe or fitting melting

Probable causes:

- ③ Melting point of Polybutylene is approximately 125°C. Direct contact with any naked flame, electric fire, or hot flue pipe etc. would cause the pipe to melt
- ③ Water/steam within pipe reaches temperatures in excess of normal boiler safety and malfunction levels. This is very rare and if found should initiate a thorough investigation of both heating and electric systems. One cause has been found to be stray electric current passing through impurities in water

Evidence: Visual examination shows material to be deformed. Surface of material may appear 'glossy'. If in any doubt please return the pipe and fitting to the Technical Advisory Department for further analysis.

Note: If a fitting is being returned, care should be taken not to damage the sample which may hinder analysis. As much of the affected installation should be returned as possible, but sufficient pipe should be left in fittings to allow pressure testing (minimum requirement 50mm). If possible a full metre of pipe should be returned complete with markings or a note made of all pipe markings.

The above notes cover some possible malfunctions generally resulting from incorrect installation or service conditions. By following the procedures and advice contained in this guide these problems will be avoided.

General Information

Hep₂O Push-fit Plumbing

Advisory service

Wavin provides a comprehensive range of support services to ensure that any queries are dealt with swiftly and efficiently.

Hep₂O is a professional product and is distributed nationwide via a network of builders' and plumbers' merchants. It is not available through DIY or other retail outlets.

For details of your nearest Hep₂O stockist visit our website at www.hep2o.co.uk

Other sources of information

The Plumbing Engineering Services Design Guide published by: The Institute of Plumbing.

Building Regulations - Approved Documents A, G and L.

BS 5449: Code of Practice for Central Heating for Domestic Premises.

BS 5955: Part 8: Specification for the installation of thermoplastics pipes and associated fittings for use in domestic hot and cold water services and heating systems.

BS 6700 and **BS EN 806:** Design, Installation, Testing and Maintenance of services supplying water for domestic use within buildings and their curtilages.

This guide follows requirements stated in the standards, byelaws and regulations listed previously. Should it differ from any new UK or European requirements issued since we went to print, please obtain clarification by calling the appropriate enquiry hotline.

Polybutylene Pipe

Hep₂O Push-fit Plumbing

Description	Nom dia mm	Cat no	Colour ref	
 <p>Plumbing and Underfloor Heating Pipe Coils – Barrier Please Note: Order pipe by unit (coil) not by metre</p>	25m ♡	10 HXX25/10W	White	
	50m ♡	10 HXX50/10W	White	
	100m ♡	10 HXX100/10W	White	
	25m ♡	15 HXX25/15W	White	
	50m ♡	15 HXX50/15W	White	
	80m ♡	15 HXX80/15W	White	
	100m ♡	15 HXX100/15W	White	
	120m ♡	15 HXX120/15W	White	
	25m ♡	22 HXX25/22W	White	
	50m ♡	22 HXX50/22W	White	
	25m ♡	28 HXX25/28W	White	
	50m ♡	28 HXX50/28W	White	
	 <p>Straight Lengths – Barrier</p>	3.0m ♡	15 HXX03/15W	White
		3.0m ♡	22 HXX03/22W	White
		3.0m ♡	28 HXX03/28W	White
	 <p>Standard Plumbing Pipe Coils – Standard Please Note: Order pipe by unit (coil) not by metre</p>	25m ♡	15 HXP25/15W	White
50m ♡		15 HXP50/15W	White	
100m ♡		15 HXP100/15W	White	
25m ♡		22 HXP25/22W	White	
50m ♡		22 HXP50/22W	White	
 <p>Straight Lengths – Standard</p>		3.0m ♡	15 HXP03/15W	White
		3.0m ♡	22 HXP03/22W	White
 <p>Pipe in Pipe System Coil of Hep₂O Barrier Pipe in Blue or Red Conduit Please Note: Order pipe by unit (coil) not by metre</p>		50m ♡	10 HXXC5010 BU	Blue
		50m ♡	10 HXXC5010 RD	Red
		50m ♡	15 HXXC5015 BU	Blue
	50m ♡	15 HXXC5015 RD	Red	
	50m ♡	22 HXXC5022 BU	Blue	
	50m ♡	22 HXXC5022 RD	Red	
	25m ♡	28 HXXC2528 BU	Blue	
	25m ♡	28 HXXC2528 RD	Red	

Important Note:
Order pipe by unit (length) not by metre. Cut lengths only available as pack quantities.

Demountable Fittings Hep₂O Push-fit Plumbing

	Description	Nom dia mm	Cat no	Colour ref
	Straight Connector			
	♥	10	HD1/10W	White
	♥	15	HD1/15W	White
	♥	22	HD1/22W	White
	Elbow 90°			
	♥	10	HD5/10W	White
	♥	15	HD5/15W	White
	♥	22	HD5/22W	White
	Equal Tee			
	♥	10	HD10/10W	White
	♥	15	HD10/15W	White
	♥	22	HD10/22W	White
	Demountable Stop-End			
	♥	10	HD62/10W	White
	♥	15	HD62/15W	White
	♥	22	HD62/22W	White
	SmartSleeve Pipe Support			
	♥	10	HX60/10W	Silver
	♥	15	HX60/15W	Silver
	♥	22	HX60/22W	Silver
	Spigot Elbow 90° Single Socket			
	♥	10	HD4/10W	White
	♥	15	HD4/15W	White
	♥	15x10	HD4A/15W	White
	Socket Reducer			
	15 x 10mm ♥	15	HD2/15W	White
	22 x 15mm ♥	22	HD2/22W	White
	28 x 22mm ♥	28	HD2/28W	White
	Socket/Socket Reducer			
	15 x 10mm ♥	15	HD3B/15W	White
	22 x 15mm ♥	22	HD3B/22W	White
	28 x 22mm ♥	28	HD3C/22W	White
	Imperial Copper Adaptor			
22mm - 3/4" ♥	22	HD3A/22 GY	Grey	



Important Note:

All fittings are pre-lubricated - no additional lubrication required.
Hep₂O fittings are fully compatible with Hep₂O and copper pipe.

Demountable Fittings Hep₂O Push-fit Plumbing

	Description	Nom dia mm	Cat no	Colour ref
	Obtuse Bend 135° Single Socket			
	♥	10	HD8/10W	White
	♥	15	HD8/15W	White
	♥	22	HD8/22W	White
	End Reduced Tee			
	22 x 15 x 22mm ♥ 28 x 22 x 28mm ♥	22 28	HD12/22W HD12/28W	White White
	Double End Reduced Tee			
	10 x 10 x 15mm ♥	15	HD18/15W	White
	10 x 10 x 22mm ♥	22	HD18A/22W	White
	15 x 15 x 22mm ♥ 22 x 22 x 28mm ♥	22 28	HD18/22W HD18/28W	White White
	Branch Reduced Tee			
	15 x 15 x 10mm ♥	15	HD13/15W	White
	22 x 22 x 10mm ♥	22	HD13A/22W	White
	22 x 22 x 15mm ♥	22	HD13/22W	White
	28 x 28 x 15mm ♥ 28 x 28 x 22mm ♥	28 28	HD13A/28W HD13/28W	White White
	Branch Reduced Tee – Spigot			
	15 x 15 x 10mm ♥ 22 x 22 x 15mm ♥	15 22	HD15/15W HD15/22W	White White
	Branch and One End Reduced Tee			
	15 x 10 x 10mm ♥	15	HD14/15W	White
	22 x 10 x 10mm ♥	22	HD14A/22W	White
	22 x 15 x 15mm ♥ 28 x 22 x 22mm ♥	22 28	HD14/22W HD14/28W	White White
	Blanking Peg			
	For Demountable Hep ₂ O Fittings			
	♥	10	HX44/10W	White
	♥	15	HX44/15W	White
	♥	22	HX44/22W	White
	♥	28	HX44/28W	White
	Tank Connector			
	with BSP tail & backnut (For cold water use only)			
	BSP 1/2"	15	HX20/15W	White
	BSP 3/4"	22	HX20/22W	White
BSP 1"	28	HX20/28W	White	
	Straight Tap Connector			
	with brass nut and alternative rubber washer			
	BSP 1/2" ♥ *	15	HD25A/15W	White
	BSP 3/4" ♥ *	15	HD25B/15W	White
BSP 3/4" ♥ *	22	HD25B/22W	White	

* For intermittent hot and cold water use up to a maximum of 65°C
Not for use with Central Heating

	Description	Nom dia mm	Cat no	Colour ref
	Bent Tap Connector with brass nut and alternative rubber washer BSP 1/2" ♡ *	15	HD27/15W	White
	Hand-Titan™ Tap Connector with rubber washer BSP 1/2" ♡ * BSP 1/2" ♡ * BSP 3/4" ♡ * BSP 3/4" ♡ *	10 15 15 22	HD26A/10W HD26A/15W HD26B/15W HD26B/22W	White White White White

* For intermittent hot and cold water use up to a maximum of 65°C
Not for use with Central Heating

Flexible Tap Connectors

Hep₂O Push-fit Plumbing

	Description	Nom dia mm	Cat no	Hose type
	Hep₂O x BSP Nut with brass nut & rubber washer			
	150mm BSP 1/2" *	15	HD425A/15W	Braided
	300mm BSP 1/2" *	15	HD125A/15W	Braided
	300mm BSP 3/4" *	15	HD125B/15W	Braided
	300mm BSP 3/4" (full bore) *	22	HD125C/22W	Braided
	300mm BSP 3/4" *	22	HD125B/22W	Braided
	500mm BSP 1/2" *	15	HD225A/15W	Braided
	500mm BSP 3/4" *	15	HD225B/15W	Braided
	500mm BSP 3/4" (full bore) *	22	HD225C/22W	Braided
	500mm BSP 3/4" *	22	HD225B/22W	Braided
	1000mm BSP 1/2" *	15	HD325A/15W	Braided
1000mm BSP 3/4" *	22	HD325B/22W	Braided	
	Hep₂O x BSP Nut with brass nut & rubber washer			
	300mm BSP 1/2" *	15	HDW125A/15W	White
	300mm BSP 3/4" *	15	HDW125B/15W	White
	300mm BSP 3/4" *	22	HDW125B/22W	White
	500mm BSP 1/2" *	15	HDW225A/15W	White
	500mm BSP 3/4" *	15	HDW225B/15W	White
500mm BSP 3/4" *	22	HDW225B/22W	White	
	Hep₂O x Hep₂O			
	300mm 15mm x 15mm *	15	HD125H/15W	Braided
	300mm 22mm x 22mm *	22	HD125H/22W	Braided
	500mm 15mm x 15mm *	15	HD225H/15W	Braided
500mm 22mm x 22mm *	22	HD225H/22W	Braided	
	Hep₂O x Hep₂O			
	300mm 15mm x 15mm *	15	HDW125H/15W	White
300mm 22mm x 22mm *	22	HDW125H/22W	White	
	Hep₂O x Elbow BSP Nut with brass nut & rubber washer			
	300mm Elbow BSP 1/2" *	15	HD125D/15W	Braided
	300mm Elbow BSP 1/2" *	15	HDW125D/15W	White

* For intermittent hot and cold water use up to a maximum of 65°C
Not for use with Central Heating

	Description	Nom dia mm	Cat no	Hose type
	Hep₂O Brass Service Valve x BSP Nut with brass nut & rubber washer			
	300mm BSP 1/2" *	15	HD125E/15W	Braided
	300mm BSP 3/4" *	22	HD125E/22W	Braided
	500mm BSP 1/2" *	15	HD225E/15W	Braided
	500mm BSP 3/4" *	15	HD225I/15W	Braided
	500mm BSP 3/4" *	22	HD225E/22W	Braided
	Hep₂O Brass Service Valve x BSP Nut with brass nut & rubber washer			
	300mm BSP 1/2" *	15	HDW125E/15W	White
	300mm BSP 3/4" *	22	HDW125E/22W	White
	Hep₂O Brass Service Valve (Handle) x BSP Nut with brass nut & rubber washer			
	300mm BSP 1/2" *	15	HD125EH/15W	Braided
	300mm BSP 3/4" *	22	HD125EH/22W	Braided
	Hep₂O x Monobloc Mixers			
	300mm 15mm x M10 * 300mm 15mm x M12 *	15 15	HD125F/15W • HD125G/15W •	Braided Braided

• Sold and priced as a pair

Auxiliary Fittings

Hep₂O Push-fit Plumbing

	Description	Nom dia mm	Cat no	Colour ref
	Adaptor Male BSP/Hep ₂ O socket DZR Brass BSP 1/2" ♡ BSP 1/2" ♡ BSP 3/4" ♡ BSP 1" ♡	10 15 22 28	HX29/10W HX29/15W HX29/22W HX29/28W	Brass Brass Brass Brass
	Adaptor Female BSP/Hep ₂ O socket DZR Brass BSP 1/2" ♡ BSP 1/2" ♡ BSP 3/4" ♡ BSP 3/4" ♡ BSP 1" ♡	10 15 15 22 28	HX28/10W HX28/15W HX24/15W HX28/22W HX28/28W	Brass Brass Brass Brass Brass
	Adaptor Male BSP/Hep ₂ O spigot DZR Brass BSP 1/2" ♡ BSP 3/4" ♡ BSP 1" ♡	15 22 28	HX31/15W HX31/22W HX31/28W	Brass Brass Brass
	Adaptor Female BSP/Hep ₂ O spigot DZR Brass BSP 1/2" ♡ BSP 3/4" ♡ BSP 1" ♡	15 22 28	HX30/15W HX30/22W HX30/28W	Brass Brass Brass
	Draincock Brass 15mm spigot DZR Brass ♡	15	HX32/15 GY	Brass
	Adaptor Converts 1/2" tap connector to 3/8" DZR Brass BSP 1/2"x 3/8" ♡		HX39 GR	Brass
	Wall Plate Elbow Hep ₂ O BSP 1/2" ♡ BSP 3/4" ♡	15 22	HX6/15W HX6/22W	Black Black
	Ball Valve Plated Brass (for hot & cold water use) 15x15mm 22x22mm	15 22	HX22/15W HX22/22W	Brass Brass
	Gate Valve – Hot/Cold DZR Brass – Hep ₂ O ends	15 22	HX35/15W HX35/22W	Brass Brass
	Stopcock – Cold Water fitted with Hep ₂ O ends	15 22	HX36/15W HX36/22W	White White

	Description	Nom dia mm	Cat no	Colour ref
	Stopcock – Cold Water Hep ₂ O to MDPE Conversion 22mm to 25mm MDPE	22	HX43/22W	White
	Shut-off Valve With hot/cold indicator insert. NB: *SEE USAGE NOTE	15	HX37/15W	White
	Appliance Valve With hot/cold indicator insert. NB: *SEE USAGE NOTE	15	HX38/15W	White
	Straight Service Valve With hot/cold indicator insert. NB: *SEE USAGE NOTE	15	HX18/15W	White
	Angled Service Valve With hot/cold indicator insert. NB: *SEE USAGE NOTE	15	HX19/15W	White
	Double-Check Valve Plastics NB: *SEE USAGE NOTE	15	HX72/15W	White
	Two Port Manifold 22x15mm ports Closed Spigot ♡	22	HX88/22W	White
	Two Port Manifold 22x15mm ports All socket ♡	22	HX88B/22W	White
	Three Port Manifold 22x15mm ports Closed Spigot ♡	22	HX89/22W	White
	Three Port Manifold 22x15mm ports All socket ♡	22	HX89B/22W	White
	Two Port Manifold 22x10mm ports All socket ♡	22	HX92B/22W	White
	Four Port Manifold 22x10mm ports All socket ♡	22	HX94B/22W	White
	Two Port Manifold 22x10mm ports Socket and closed spigot ♡	22	HX92/22W	White

***For intermittent hot and cold water use up to a maximum of 65°C
Not for use with Central Heating**

Auxiliary Fittings

Hep₂O Push-fit Plumbing



	Description	Nom dia mm	Cat no	Colour ref
	Four Port Manifold 22x10mm ports Socket and closed spigot ♡	22	HX94/22W	White
	Four Port Manifold 22x10mm ports Socket and closed spigot, on one side ♡	22	HX96/22W	White
	Four Port Manifold 22x10mm ports All socket, on one side ♡	22	HX96B/22W	White
	One Port Valved Manifold Plated Brass 3/4" BSP Male/Female 22mm Hep ₂ O port ♡	22	HX91T/22W	
	Two Port Valved Manifold Plated Brass 3/4" BSP Male/Female 15mm Hep ₂ O ports ♡	15	HX92T/15W	
	Three Port Valved Manifold Plated Brass 3/4" BSP Male/Female 15mm Hep ₂ O ports ♡	15	HX93T/15W	
	Four Port Valved Manifold Plated Brass 3/4" BSP Male/Female. 15mm Hep ₂ O ports ♡	15	HX94T/15W	
	Manifold End Caps 3/4" BSP Female End Cap 3/4" BSP Male End Cap		HX97 GY HX98 GY	
	Manifold Bracket – Pair for HX92T/15, HX93T/15 & HX94T/15		HX95A GR	
	Radiator Outlet Back Box Plastic (for stud wall)		HX109 GY	White
	Radiator Outlet Back Box Metal (for solid wall)		HX110 GY	Silver
	Radiator Outlet Cover with Flap For use with HX109 & HX110		HX113 WH	White
	Back Box Grommet For use with HX110		HX112 GY	Black

Tools, Fixings and Accessories Hep₂O Push-fit Plumbing

	Description	Nom dia mm	Cat no	Colour ref
	HepKey Plus Demounting Tool	10	HX79/10W	Green
		15	HX79/15W	Blue
		22	HX79/22W	Red
		28	HX79/28W	Orange
	HepKey Demounting Tool	10	HX78/10W	Green
		15	HX78/15W	Blue
		22	HX78/22W	Red
		28	HX78/28W	Orange
	HepTool Demounting Tool 10/28mm 15/22mm	10	HX77/10W	Silver
		15	HX77/15W	Silver
	Cold Forming Bend Fixture Metal with passivate finish	15	HX75/15 GR	
		16	HX75/16 GR	
		22	HX75/22 GR	
	Pipe Cutter – Scissor Type Standard		HD74 GR	Red
	Pro Cutter		HD75 GR	Red
	Pipe Cutter – Ratchet Type up to 42mm pipe up to 28mm pipe		HD77 GR	Red
			HD78 GR	Red
	Hep₂O Joint Test Kit Hep ₂ O Joint Test Kit Replacement Seals		HX81 GR	Red
			HX81A GR	Red
	Pipe Clips – Screw	15	HX85/15W	White
		22	HX85/22W	White
		28	HX85/28W	White
	Pipe Clip – Spacers	15	HX86/15W	White
		22	HX86/22W	White
	Pipe Clip Cable Type	10	HX65/10W	White
		15	HX65/15W	White
		22	HX65/22W	White
		28	HX65/28W	White

Tools, Fixings and Accessories

Hep₂O Push-fit Plumbing

	Description	Nom dia mm	Cat no	Colour ref
	Hep₂O Silicone Lubricant Spray 400 ml Aerosol Can Hep ₂ O Fittings		HX200	
	Flat Tap Connector Washers – Rubber	15 22	HX58/15 GY HX58/22 GY	
	Conical Tap Connector Washers – Rubber	15 22	HX57/15 GR HX57/22 GR	

Conduit System

Hep₂O Push-fit Plumbing

	Description	Nom dia mm	Cat no	Colour ref
	Conduit Pipe	15 15 22 22	HXC25/15 BL HXC50/15 BL HXC25/22 BL HXC50/22 BL	Black Black Black Black
	Conduit Junction Box		HX100 BL	
	Conduit Junction Box Lid		HX104 BL	
	Conduit Terminal	15	HX101/15W	Green
	Terminal Back Plate		HX103 BL	

Discover our broad portfolio at
www.wavin.co.uk

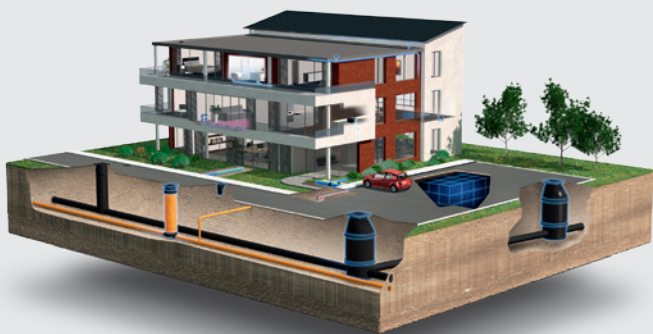

Water management | **Plumbing and heating** | Waste water drainage
Water and gas distribution | Cable ducting

Wavin Limited

Registered Office
Edlington Lane
Doncaster | DN12 1BY
Tel. 0844 856 5152
www.wavin.co.uk | info@wavin.co.uk



CONNECT TO BETTER